

# Panasonic<sup>®</sup>

## Basic Operating Instructions Digital Camera

Model No. **DMC-FT25**

# LUMIX

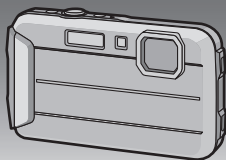

Please read these instructions carefully before using this product, and save this manual for future use.



More detailed instructions on the operation of this camera are contained in “Operating Instructions for advanced features (PDF format)” in the supplied CD-ROM. Install it on your PC to read it.



## Dear Customer,

We would like to take this opportunity to thank you for purchasing this Panasonic Digital Camera. Please read these Operating Instructions carefully and keep them handy for future reference. Please note that the actual controls and components, menu items, etc. of your Digital Camera may look somewhat different from those shown in the illustrations in these Operating Instructions.

### Carefully observe copyright laws.

- Recording of pre-recorded tapes or discs or other published or broadcast material for purposes other than your own private use may infringe copyright laws. Even for the purpose of private use, recording of certain material may be restricted.

## Information for Your Safety

### WARNING:

To reduce the risk of fire, electric shock or product damage,

- Do not let water or other liquids drip or splash inside the unit.
- Do not expose accessories (battery pack, battery charger, AC adaptor, SD memory card and etc.) to rain, moisture, dripping or splashing.
- Use only the recommended accessories.
- Do not remove covers.
- Do not repair this unit by yourself. Refer servicing to qualified service personnel.

The socket outlet shall be installed near the equipment and shall be easily accessible.

### ■ Product identification marking

Product	Location
Digital Camera	Bottom
Battery Charger	Bottom

## ■ About the battery pack

### CAUTION

- Danger of explosion if battery is incorrectly replaced. Replace only with the type recommended by the manufacturer.
  - When disposing the batteries, please contact your local authorities or dealer and ask for the correct method of disposal.
- 
- Do not heat or expose to flame.
  - Do not leave the battery(ies) in a car exposed to direct sunlight for a long period of time with doors and windows closed.

### Warning

Risk of fire, explosion and burns. Do not disassemble, heat above 60 °C or incinerate.

## ■ About the battery charger

### CAUTION!

**To reduce the risk of fire, electric shock or product damage,**

- **Do not install or place this unit in a bookcase, built-in cabinet or in another confined space. Ensure this unit is well ventilated.**
- 
- The battery charger is in the standby condition when the AC power supply cord is connected. The primary circuit is always "live" as long as the power cord is connected to an electrical outlet.

## ■ Cautions for Use

- Do not use any other USB connection cables except the supplied one or a genuine Panasonic USB connection cable (DMW-USBC1: optional).
- Always use a genuine Panasonic AV cable (DMW-AVC1: optional).

In the event of abnormal operation (e.g. if the unit emits smoke or an unusual smell), immediately stop operating the unit and consult the Panasonic Customer Care Centre on 132600.

### **Keep this unit as far away as possible from electromagnetic equipment (such as microwave ovens, TVs, video games etc.).**

- If you use this unit on top of or near a TV, the pictures and/or sound on this unit may be disrupted by electromagnetic wave radiation.
- Do not use this unit near cell phones because doing so may result in noise adversely affecting the pictures and/or sound.
- Recorded data may be damaged, or pictures may be distorted, by strong magnetic fields created by speakers or large motors.
- Electromagnetic wave radiation generated by microprocessors may adversely affect this unit, disturbing the pictures and/or sound.
- If this unit is adversely affected by electromagnetic equipment and stops functioning properly, turn this unit off and remove the battery or disconnect AC adaptor (DMW-AC5G: optional). Then reinsert the battery or reconnect AC adaptor and turn this unit on.

### **Do not use this unit near radio transmitters or high-voltage lines.**

- If you record near radio transmitters or high-voltage lines, the recorded pictures and/or sound may be adversely affected.

-If you see this symbol-

**Information on Disposal in other Countries outside the European Union**

This symbol is only valid in the European Union.

If you wish to discard this product, please contact your local authorities or dealer and ask for the correct method of disposal.



# Contents

Information for Your Safety.....	2
Before Use .....	7
Standard Accessories .....	8
(Important) About the Waterproof/Dustproof and Anti-shock Performance of the Camera .....	10
Names and Functions of Main Parts .....	14
Charging the Battery.....	15
Inserting and Removing the Card (optional)/the Battery .....	16
Sequence of operations .....	17
Reading the Operating Instructions (PDF format) .....	19
Installing supplied software.....	20
Specifications .....	21
Limited Warranty (ONLY FOR AUSTRALIA).....	23

## Before Use

Please be sure to read “(Important) About the Waterproof/Dustproof and Anti-shock Performance of the Camera” (P10) before using this unit underwater to prevent the unit from being mishandled, which may cause water to seep in.

- Do not apply strong shock or vibration by dropping or knocking the camera. Also, do not apply strong pressure to the camera.
  - Waterproof performance may be impaired.
  - Lens or LCD monitor may be damaged.
  - It may cause malfunction in the performance or the function.

### ■ When inner side of the lens is fogged (condensation)

It is not a malfunction or failure of the camera. It may be caused by the environment in which the camera is used.

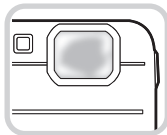

#### What to do when inner side of the lens is fogged

- Turn off the power and open the side door in a place with constant ambient temperature, away from high temperatures, humidity, sand and dust. The fog will disappear naturally in 10 minutes to 2 hours with the side door open when the temperature of the camera gets close to the ambient temperature.
- Contact Panasonic if the fogging does not disappear.

#### Conditions in which inner side of the lens may be fogged

Condensation may occur and the inner side of the lens may be fogged when the camera is used in areas that undergo a significant change in temperature or in high humidity, such as the following:

- When the camera is used underwater suddenly after being on a hot beach etc.
- When the camera is moved to a warm area from a cold area, such as at a ski resort or at high altitude
- When the side door is opened in a high-humidity environment

# Standard Accessories

Check that all the accessories are supplied before using the camera.  
Product numbers correct as of January 2013. These may be subject to change.

- 1 Battery Pack  
(Indicated as **battery pack** or **battery** in the text)  
Charge the battery before use.
- 2 Battery Charger  
(Indicated as **battery charger** or **charger** in the text)
- 3 AC Cable
- 4 USB Connection Cable
- 5 CD-ROM
  - Software
  - Operating Instructions for advanced featuresInstall on your PC before use.
- 6 Hand Strap
- 7 Silicone Jacket

- Supplied accessories are not waterproof (excluding Silicone Jacket).
- SD Memory Card, SDHC Memory Card and SDXC Memory Card are indicated as **card** in the text.
- **The card is optional.**  
**You can record or play back pictures on the built-in memory when you are not using a card.**
- Consult the dealer or Panasonic if you lose the supplied accessories. (You can purchase the accessories separately.)

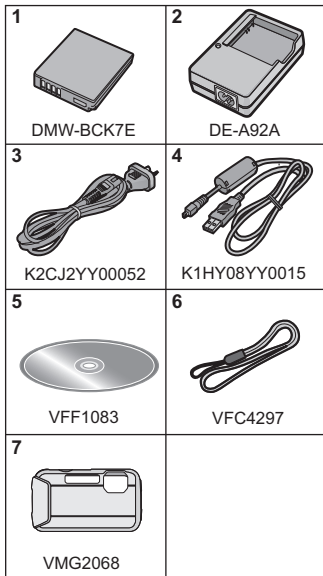



## Attaching the Silicone Jacket

**Attach is recommended to prevent unintentional opening of the side door when used in the mountains or near water.**

- Check that this unit is turned off.
- Attach the Silicone Jacket where there is no sand or dust.

### Securely attach the Silicone Jacket to the camera.

- Attach the Silicone Jacket carefully. It may get damaged when attached forcefully.
- Be sure to remove any foreign objects (sand etc.) or water (sea water etc.) adhered inside the Silicone Jacket. If not removed, the foreign objects or water may scratch or dirty the camera. We recommend that you remove the Silicone Jacket from the camera, rinse, and then wipe away the water with a soft dry cloth.



### ■ Maintenance after using

- Remove the silicone jacket from the unit carefully. It may get damaged when removed forcefully.
- Take the camera out of the Silicone Jacket, and check that foreign objects (sand etc.) or water (sea water etc.) are not adhered.
- Rinse with water, wipe off water with a soft dry cloth, and dry the camera in a well ventilated shaded area.
- Do not dry the camera with hot air from a dryer or similar. It may become unusable due to deformation.
- Do not use chemicals such as benzine, thinner, alcohol, or cleanser, or soap or detergents.
- After use, remove the Silicone Jacket. Do not store the camera for a long period of time with the Silicone Jacket still attached.

# (Important) About the Waterproof/ Dustproof and Anti-shock Performance of the Camera

## Waterproof/Dustproof Performance

This camera's waterproof/dustproof rating complies with the "IPX8" and "IP6X" ratings. Provided the care and maintenance guidelines described in this document are strictly followed, this camera can operate underwater, to a depth not exceeding 7 m for a time not exceeding 60 minutes. (\*1)

## Anti-shock Performance

This camera also complies with "MIL-STD 810F Method 516.5-Shock". The camera has cleared a drop test from a height of 1.5 m onto 3 cm thick plywood. In most cases this camera should not sustain any damage if dropped from a height not exceeding 1.5 m. (\*2)

**This does not guarantee no destruction, no malfunction, or waterproofing in all conditions.**

- \*1 This means that the camera can be used underwater for specified time in specified pressure in accordance with the handling method established by Panasonic.
- \*2 "MIL-STD 810F Method 516.5-Shock" is the test method standard of the U.S. Defense Department, which specifies performing drop tests from a height of 122 cm, at 26 orientations (8 corners, 12 ridges, 6 faces) using 5 sets of devices, and passing the 26 orientation drops within 5 devices. (If failure occurs during the test, a new set is used to pass the drop orientation test within a total of 5 devices)  
Panasonic's test method is based on the above "MIL-STD 810F Method 516.5-Shock". However, the drop height was changed from 122 cm to 150 cm dropping onto 3 cm thick plywood. This drop test was passed.  
(Disregarding appearance change such as loss of paint or distortion of the part where drop impact is applied.)

## ■ Handling of the camera

- Waterproofing is not guaranteed if the unit is subject to an impact as a result of being hit or dropped etc. If an impact to the camera occurs, it should be inspected (subject to a fee) by Panasonic to verify that the waterproofing is still effective.
- When the camera is splashed with detergent, soap, hot spring, bath additive, sun oil, sun screen, chemical, etc., wipe it off immediately.
- Waterproof function of the camera is for sea water and fresh water only.
- Any malfunction caused by customer misuse, or mishandling will not be covered by the warranty.
- The inside of this unit is not waterproof. Water leakage will cause malfunction.
- Supplied accessories are not waterproof (excluding Silicone Jacket).
- Card and battery are not waterproof. Do not handle with a wet hand. Also, do not insert wet card or battery into the camera.
- Do not leave the camera for a long period of time in places where the temperature is very low (such as at ski resorts or high altitudes) or where the temperature may exceed 40 °C (such as inside cars in strong sunlight, close to a heater, on boats, or on the beach). (Waterproof performance may become degraded.)

## ■ About the [Precautions] demonstration display ([Requirements for Underwater use])

- [Precautions] is displayed when the power is turned on for the first time after purchase, with the side door completely closed.
- Please check beforehand to maintain the waterproof performance.

### 1 Press ◀ to select [Yes], and press [MENU/SET].

- It will automatically skip to the clock setting screen if [No] is selected before it starts.

### 2 Press ◀/▶ to select the picture.

◀: Return to the previous screen

▶: View the next screen

- It can be forcefully ended by pressing [MENU/SET].
- When it is forcefully ended while checking by turning the unit off or pressing [MENU/SET], [Precautions] is displayed every time the power is turned on.

### 3 After the final screen (12/12), press [MENU/SET] to finish.

- When [MENU/SET] is pressed after the final screen (12/12), [Precautions] is not displayed from the next time the power is turned on.
- This can also be viewed from [Precautions] in the [Setup] menu.

## Check before using underwater

**Always wipe the rubber seal on the side door and the area where rubber seal sits with a dry, lint-free cloth.**

### 1 Check that there are no foreign objects on the inner side of the side door.

- If there is any foreign object, such as lint, hair, sand, etc., on the surrounding area, water will leak within a few seconds causing malfunction.
- Wipe it off with a dry soft cloth if there is any liquid.  
It may cause water leaks and malfunction if you use the camera with liquid adhered.
- If foreign objects are present, wipe them off with a dry, lint-free cloth.
- Be extremely careful to remove the small sand etc. that may adhere to the sides and corners of the rubber seal.

### 2 Check for cracks and deformation of the rubber seal on the side door.

- The integrity of the rubber seals may decrease after about 1 year, with use and age. To avoid permanently damaging the camera the seals should be replaced once each year. Please contact Panasonic for related costs and other information.

### 3 Close the side door securely.

- (A) [LOCK] switch (grey part)
- (B) Red part
- (C) Released state
- (D) Locked state

- Lock the [LOCK] switch securely until the red part is no longer visible.
- To prevent water intrusion, be careful not to catch foreign objects such as liquids, sand, hair, dust, or the strap cord.

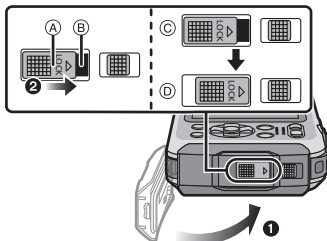

**Do not open or close the side door in places with sand and dust, close to water, or with wet hands. Sand or dust adhering may cause water leaks.**

### Using the camera underwater

- Use the camera underwater to 7 m with the water temperature between 0 °C and 40 °C.
- Do not use for scuba diving (Aqualung).
- Do not use the camera at a depth of over 7 m.
- Do not use it in the hot water over 40 °C (in the bath or hot spring).
- Do not use the camera underwater longer than 60 minutes continuously.
- Do not open or close the side door underwater.
- Do not apply shock to the camera underwater. (Waterproof performance may not be maintained, and there is a chance of water leak.)
- Do not dive into the water holding the camera. Do not use the camera in a location where the water will splash strongly, such as rapid flow or waterfall. (Strong water pressure may be applied, and it may cause malfunction.)
- The camera will sink in the water. Take care not to drop the camera and lose it underwater by securely placing the strap around your wrist or similar measure.

### Caring of the camera after using it underwater

**Do not open or close the side door until the sand and dust is removed by rinsing the camera with water.**

**Make sure to clean the camera after using it.**

- Thoroughly wipe off any water droplets, sand, and saline matter on your hands, body, hair, etc.
- It is recommended to clean the camera indoors, avoiding places where water spray or sand may fall.

**After using it underwater, always clean the camera rather than leaving it in a dirty state.**

- Leaving the camera with foreign objects or saline matter on it may cause damage, discolouration, corrosion, unusual odour, or deterioration of the waterproof performance.

## 1 Rinse with water with the side door closed.

- After use at the seaside or underwater, soak the unit in fresh water pooled in a shallow container for 10 minutes or less.
- If the zoom button or camera [ON/OFF] button do not press smoothly, it may be caused by an adhesion of foreign objects. Using in such a state may cause malfunctions, such as locking up, so wash off any foreign objects by shaking the camera in fresh water.
- Bubbles may come out of the drainage hole when you immerse the camera in water, but this is not a malfunction.



## 2 Drain water by holding the camera upside-down (A) and the right way up (B) and shaking it lightly a few times.

- After using the camera at the beach or in water, or after washing it, water may remain around the speaker and microphone for a while and may cause a drop in volume or sound distortion.
- Make sure to put your hand through the strap to prevent the camera from falling.

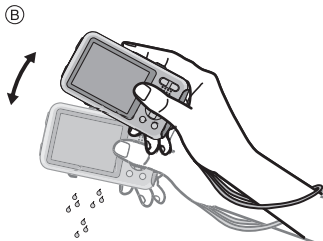
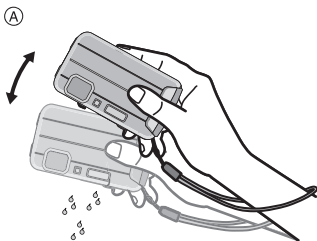

## 3 Wipe off water drops on the camera with a dry soft cloth and dry the camera in a shaded area which is well ventilated.

- Dry the camera by standing it on a dry cloth. This unit incorporates drain design, draining water in gaps in the camera [ON/OFF] button and zoom button etc.
- Do not dry the camera with hot air from dryer or similar. Waterproof performance will deteriorate due to deformation.
- Do not use chemicals such as benzene, thinner, alcohol or cleanser, soap or detergents.



## 4 Confirm that there are no water droplets, open the side door, and wipe off any water droplets or sand left inside using a soft dry cloth.

- Water droplets may adhere to the card or battery when the side door is opened without thoroughly drying. Also, water may accumulate in the gap around the card/battery slot or the terminal connector. Be sure to wipe any water off with a soft dry cloth.
- The water droplets may seep into the camera when the side door is closed while it is still wet, causing condensation or failure.

# Names and Functions of Main Parts

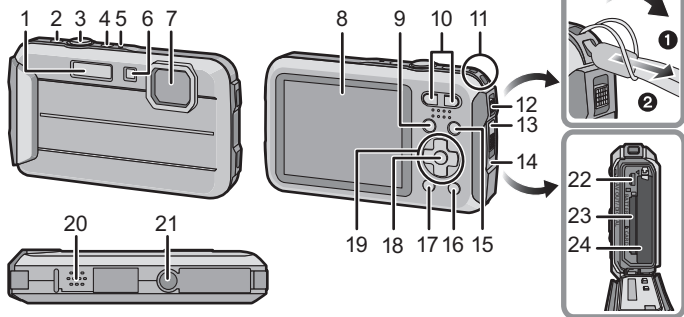

- |    |   |  |                         |
|----|---|--|-------------------------|
| 1  | Flash   | 17   | [DISP.] button          |
| 2  | Motion picture button                                 | 18   | [MENU/SET] button       |
| 3  | Shutter button  | 19   | Cursor buttons          |
| 4  | Camera [ON/OFF] button                                | 20   | Speaker                 |
| 5  | Microphone  | <ul style="list-style-type: none"> <li>• Be careful not to cover the speaker with your finger. Doing so may make sound difficult to hear.</li> </ul>                                   |                         |
| 6  | Self-timer indicator/<br>AF Assist Lamp/<br>LED light | 21   | Tripod mount            |
| 7  | Lens  | <ul style="list-style-type: none"> <li>• A tripod with a screw length of 5.5 mm or more may damage this unit if attached.</li> </ul>   |                         |
| 8  | LCD monitor   | 22   | [AV OUT/DIGITAL] socket |
| 9  | [MODE] button   | 23   | Card slot               |
| 10 | Zoom button   | 24   | Battery slot            |
| 11 | Strap eyelet  | <ul style="list-style-type: none"> <li>• When using an AC adaptor, ensure that the Panasonic DC coupler (DMW-DCC10: optional) and AC adaptor (DMW-AC5G: optional) are used.</li> </ul> |                         |
| 12 | Release lever   | <ul style="list-style-type: none"> <li>• Always use a genuine Panasonic AC adaptor (DMW-AC5G: optional).</li> </ul>  |                         |
| 13 | [LOCK] switch   | <ul style="list-style-type: none"> <li>• When using an AC adaptor, use the AC cable supplied with the AC adaptor.</li> </ul>   |                         |
| 14 | Side door   |  |                         |
| 15 | [▶] (Playback) button                                 |  |                         |
| 16 | [Q.MENU] button/[⏏/↵] (Delete/<br>Cancel) button      |  |                         |

# Charging the Battery

Use the dedicated charger and battery.

- The battery is not charged when the camera is shipped. Charge the battery before use.
- Charge the battery with the charger indoors (10 °C to 30 °C).

- 1** Attach the battery paying attention to the direction of the battery.

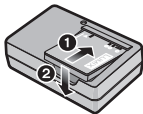

- 2** Connect the AC cable.

- The [CHARGE] indicator (A) lights up and charging begins.

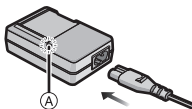

## ■ About the [CHARGE] indicator

On: Charging.

Off: Charging has completed. (Charging time: Approx. 120 min)

## ■ About batteries that you can use with this unit

The battery that can be used with this unit is DMW-BCK7E.

# Inserting and Removing the Card (optional)/the Battery

- Check that this unit is turned off.
- **Confirm that there is no foreign object.**
- We recommend using a Panasonic card.

1

①: Slide the [LOCK] switch (A), and release the lock.

②: Slide the release lever (B) and open the side door.

- Always use genuine Panasonic batteries (DMW-BCK7E).
- If you use other batteries, we cannot guarantee the quality of this product.

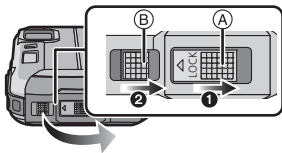

2

**Battery:** Being careful about the battery orientation, insert all the way until you hear a locking sound and then check that it is locked by lever (C). Pull the lever (C) in the direction of the arrow to remove the battery.

**Card:** Push it securely all the way until you hear a “click” while being careful about the direction in which you insert it. To remove the card, push the card until it clicks, then pull the card out upright.

ⓓ: Do not touch the connection terminals of the card.

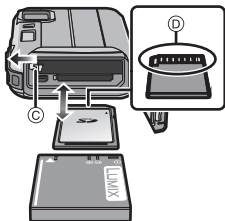

3

Close the side door until it clicks, and then lock the [LOCK] switch by sliding it toward [▶].

- Confirm that the red part on the [LOCK] switch is not showing.

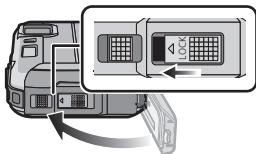

## Note

- Keep the Memory Card out of reach of children to prevent swallowing.



# Sequence of operations

## 1 Press camera [ON/OFF] button.

- The clock is not set when the camera is shipped. Set the date and time before using the camera.

## 2 Press the shutter button halfway to focus and then press it fully to take the picture.

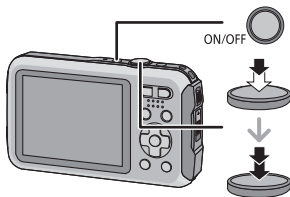

## ■ Selecting the Recording Mode

Press [MODE] to select the Recording Mode.

: Take pictures with automatic settings.

: Take pictures with your own settings.

: Record while checking the image effect.

: This mode is optimal for taking pictures of sporting events, etc.

: This mode is optimal for taking pictures that show the snow as white as possible at a ski resort or a snow-covered mountain.

: This mode is optimal for taking pictures to 3 m underwater and at the beach.

: This mode is optimal for taking pictures at depths of 3 m to 7 m.

: This mode allows you to take panorama pictures.

**SCN**: Take pictures according to scene.

---

## ■ Recording Motion Pictures

Start recording by pressing the motion picture button.

- Stop the recording by pressing the motion picture button again.
  - Maximum time to record motion pictures continuously is 29 minutes 59 seconds.  
The maximum available recording time continuously is displayed on the screen.
- 

## ■ Setting the Menu

Press [MENU/SET] to display the menu screen to change the recording function, camera settings, and other settings.

---

## ■ Playing Back Pictures

Press [▶].

- Press ◀/▶ to select the picture.
- 

## ■ Deleting Pictures

Select the picture, and then press [🗑️/↶].

- Confirmation screen is displayed. Picture is deleted by selecting [Yes].
- 

### ■ About the [LED Light] ([Setup])

If you set to [🔦], and press and hold down ▶ (🔦) on the recording standby screen, the LED light will come on for 60 seconds.



# Reading the Operating Instructions (PDF format)

More detailed instructions on the operation of this camera are contained in “Operating Instructions for advanced features (PDF format)” in the supplied CD-ROM. Install it on your PC to read it.

## ■ For Windows

- 1 Turn the PC on and insert the CD-ROM containing the Operating Instructions (supplied).
- 2 Click the [Operating Instructions].
- 3 Select the desired language and then click [Operating Instructions] to install.  
Ⓐ To return to the install menu.
- 4 Double click the “Operating Instructions” shortcut icon on the desktop.

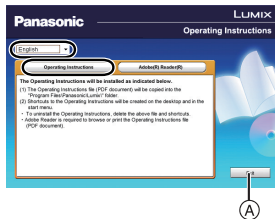

## ■ When the Operating Instructions (PDF format) will not open

You will need Adobe Acrobat Reader 5.0 or later or Adobe Reader 7.0 or later to browse or print the Operating Instructions (PDF format).

- You can download and install a version of Adobe Reader that you can use with your OS from the following Web Site.  
<http://get.adobe.com/reader/otherversions/>

# Installing supplied software

- The supplied CD-ROM includes the following software.
  - PHOTOfunSTUDIO 9.0 SE (Windows8/7/Vista/XP)
  - LoiLoScope 30 day full trial version (Windows8/7/Vista/XP)  
(This will only install a shortcut to the trial version download site.)
- Before inserting the CD-ROM, close all running applications.

## 1 Check the environment of your PC.

- For details about information such as the operating environment or operating method, refer to the “Operating Instructions for advanced features (PDF format)” or the operating instructions for the respective software programmes.

## 2 Insert the CD-ROM with the supplied software.

- When you insert the supplied CD-ROM, the install menu will start.

## 3 Click on the [Applications] on the install menu.

## 4 Click on the [Recommended Installation].

- Proceed with installation according to messages appearing on the screen.

### Note

- The software compatible with your PC will be installed.
- “PHOTOfunSTUDIO” and “LoiLoScope” are not compatible with Mac.

# Specifications

Specifications are subject to change without notice.

## Digital Camera:

Information for your safety

<b>Power Source:</b>	DC 5.1 V
<b>Power Consumption:</b>	1.0 W (When recording) 0.6 W (When playing back)

<b>Camera effective pixels</b>	16,100,000 pixels	
<b>Image sensor</b>	1/2.33" CCD, total pixel number 16,600,000 pixels, Primary colour filter	
<b>Lens</b>	Optical 4× zoom, f=4.5 mm to 18 mm (35 mm film camera equivalent: 25 mm to 100 mm)/F3.9 (Wide) to F5.7 (Tele)	
<b>Image stabiliser</b>	Optical method	
<b>Focus range</b>	Normal	50 cm (Wide)/1 m (Tele) to ∞
	Macro/ Intelligent auto/ Motion picture	5 cm (Wide)/1 m (Tele) to ∞
	Scene Mode	There may be differences in the above settings.
<b>Shutter system</b>	Electronic shutter+ Mechanical shutter	
<b>Minimum Illumination</b>	Approx. 14 lx (when i-low light is used, the shutter speed is 1/25th of a second)	
<b>Shutter speed</b>	8 seconds to 1/1300th of a second [Starry Sky] Mode: 15 seconds, 30 seconds, 60 seconds	
<b>Exposure (AE)</b>	Auto (Programme AE)	
<b>Metering mode</b>	Multiple	
<b>LCD monitor</b>	2.7" TFT LCD (4:3) (Approx. 230,000 dots) (field of view ratio about 100%)	
<b>Microphone</b>	Monaural	
<b>Speaker</b>	Monaural	
<b>Recording media</b>	Built-in Memory (Approx. 70 MB)/SD Memory Card/ SDHC Memory Card/SDXC Memory Card	
<b>Recording file format</b>		
<b>Still Picture</b>	JPEG (based on "Design rule for Camera File system", based on "Exif 2.3" standard)/DPOF corresponding	
<b>Motion pictures</b>	MP4	
<b>Audio compression format</b>	AAC	

<b>Interface</b>	
<b>Digital</b>	“USB 2.0” (High Speed)
<b>Analogue video</b>	NTSC/PAL Composite (Switched by menu)
<b>Audio</b>	Audio line output (monaural)
<b>Terminal</b>	
<b>[AV OUT/DIGITAL]</b>	Dedicated jack (8 pin)
<b>Dimensions</b> (excluding the projecting parts)	Approx. 103.7 mm (W)×58.3 mm (H)×19.7 mm (D)
<b>Mass</b>	Approx. 144 g (with card and battery) Approx. 125 g (excluding card and battery)
<b>Operating temperature</b>	−10 °C* to 40 °C * The performance of the battery (number of recordable pictures/operating time) may decrease temporarily when using in a temperature between −10 °C and 0 °C (cold places such as ski resorts or places at high altitude).
<b>Operating humidity</b>	10%RH to 80%RH
<b>Waterproof performance</b>	Equivalent to IEC 60529 “IPX8”. (Usable for 60 minutes in 7 m water depth)
<b>Crash resistance performance</b>	The test method of the camera is in compliance with “MIL-STD 810F Method 516.5-Shock”*. * “MIL-STD 810F Method 516.5-Shock” is the test method standard of the U.S. Defense Department, which specifies performing drop tests from a height of 122 cm, at 26 orientations (8 corners, 12 ridges, 6 faces) using 5 sets of devices, and passing the 26 orientation drops within 5 devices. (If failure occurs during the test, a new set is used to pass the drop orientation test within a total of 5 devices) • Panasonic’s test method is based on the above “MIL-STD 810F Method 516.5-Shock”. However, the drop height was changed from 122 cm to 150 cm dropping onto 3 cm thick plyboard. This drop test was passed. (Disregarding appearance change such as loss of paint or distortion of the part where drop impact is applied.) <b>There is no guarantee of not breaking or malfunctioning under all conditions.</b>
<b>Dustproof performance</b>	Equivalent to IEC 60529 “IP6X”.

#### Battery Charger (Panasonic DE-A92A): Information for your safety

<b>Input:</b>	AC ~ 110 V to 240 V, 50/60 Hz, 0.2 A
<b>Output:</b>	DC === 4.2 V, 0.43 A
<b>Operating temperature:</b>	0 °C* to 40 °C * The battery cannot be recharged in a temperature less than 0 °C. (The [CHARGE] indicator blinks when the battery cannot be recharged.)

#### Battery Pack (lithium-ion) (Panasonic DMW-BCK7E): Information for your safety

<b>Voltage/capacity:</b>	3.6 V/680 mAh
--------------------------	---------------

# Limited Warranty (ONLY FOR AUSTRALIA)

## Panasonic Warranty

- The product is warranted for 12 months from the date of purchase. Subject to the conditions of this warranty Panasonic or its Authorised Service Centre will perform necessary service on the product without charge for parts or labour, if in the opinion of Panasonic, the product is found to be faulty within the warranty period.
- This warranty only applies to Panasonic products purchased in Australia and sold by Panasonic Australia or its Authorised Distributors or Dealers and only where the products are used and serviced within Australia or its territories. Warranty cover only applies to service carried out by a Panasonic Authorised Service Centre and only if valid proof of purchase is presented when warranty service is requested.
- This warranty only applies if the product has been installed and used in accordance with the manufacturer's recommendations (as noted in the operating instructions) under normal use and reasonable care (in the opinion of Panasonic). The warranty covers normal domestic use only and does not cover damage, malfunction or failure resulting from use of incorrect voltages, incorrect installation, accident, misuse, neglect, build-up of dirt or dust, abuse, maladjustment of customer controls, mains supply problems, thunderstorm activity, infestation by insects or vermin, tampering or repair by unauthorised persons (including unauthorised alterations), introduction of sand, humidity or liquids, commercial use such as hotel, office, restaurant, or other business or rental use of the product, exposure to abnormally corrosive conditions or any foreign object or matter having entered the product.
- This warranty does not cover the following items unless the fault or defect existed at the time of purchase:
  - Cabinet Part(s)
  - Video or Audio Tapes
  - SD cards or USB devices
  - User replaceable Batteries etc
  - DVD, Blu-ray or Recordable Discs
  - Video / Audio Heads from wear and tear in normal use
  - Information stored on Hard Disk Drive, USB stick or SD card
  - DTV reception issues caused by TV Aerial / Cabling / Wall socket(s)
- Some products may be supplied with Ethernet connection hardware. The warranty is limited on such products and will not cover
  - Internet and or DLNA connection / setup related problems
  - Access fees and or charges incurred for internet connection
  - The use of incompatible software or software not specifically stipulated in the product operations manual; and
  - Any indirect or consequential costs associated with the incorrect use or misuse of the hardware, its connection to the internet or any other device.
- To claim warranty service, when required, you should:
  - Telephone Panasonic's Customer Care Centre on 132600 or visit our website referred to below and use the Service Centre Locator for the name/address of the nearest Authorised Service Centre.
  - Send or take the product to a Panasonic Authorised Service Centre together with your proof of purchase receipt as a proof of purchase date. Please note that freight and insurance to and / or from your nearest Authorised Service Centre must be arranged by you.
  - Note that home or pick-up/delivery service is available for the following products in the major metropolitan areas of Australia or the normal operating areas of the nearest Authorised Service Centres:
    - Plasma/LCD televisions / displays (screen size greater than 103 cm)
- The warranties hereby conferred do not extend to, and exclude, any costs associated with the installation, de-installation or re-installation of a product, including costs related to the mounting, de-mounting or remounting of any screen, (and any other ancillary activities), delivery, handling, freighting, transportation or insurance of the product or any part thereof or replacement of and do not extend to, and exclude, any damage or loss occurring by reason of, during, associated with, or related to such installation, de-installation, re-installation or transit.

Panasonic Authorised Service Centres are located in major metropolitan areas and most regional centres of Australia, however, coverage will vary dependant on product. For advice on exact Authorised Service Centre locations for your product, please telephone our Customer Care Centre on 132600 or visit our website and use the Service Centre Locator.

In addition to your rights under this warranty, Panasonic products come with consumer guarantees that cannot be excluded under the Australian Consumer Law. If there is a major failure with the product, you can reject the product and elect to have a refund or to have the product replaced or if you wish you may elect to keep the goods and be compensated for the drop in value of the goods. You are also entitled to have the product repaired or replaced if the product fails to be of acceptable quality and the failure does not amount to a major failure.

If there is a major failure in regard to the product which cannot be remedied then you must notify us within a reasonable period by contacting the Panasonic Customer Care Centre. If the failure in the product is not a major failure then Panasonic may choose to repair or replace the product and will do so in a reasonable period of time from receiving notice from you.

**THIS WARRANTY CARD AND THE PURCHASE DOCKET (OR SIMILAR PROOF OF PURCHASE)  
SHOULD BE RETAINED BY THE CUSTOMER AT ALL TIMES**

If you require assistance regarding warranty conditions or any other enquiries, please visit the **Panasonic Australia** website [www.panasonic.com.au](http://www.panasonic.com.au) or contact by phone on **132 600**  
*If phoning in, please ensure you have your operating instructions available.*

**Panasonic Australia Pty. Limited**

ACN 001 592 187 ABN 83 001 592 187

1 Innovation Road, Macquarie Park NSW 2113

PRO-031-F11 Issue: 4.0

01-01-2011

- SDXC Logo is a trademark of SD-3C, LLC.
- QuickTime and the QuickTime logo are trademarks or registered trademarks of Apple Inc., used under license therefrom.
- Mac and Mac OS are trademarks of Apple Inc., registered in the U.S. and other countries.
- Windows and Windows Vista are either registered trademarks or trademarks of Microsoft Corporation in the United States and/or other countries.
- This product uses "DynaFont" from DynaComware Corporation. DynaFont is a registered trademark of DynaComware Taiwan Inc.
- Other names of systems and products mentioned in these instructions are usually the registered trademarks or trademarks of the manufacturers who developed the system or product concerned.



This product is licensed under the AVC patent portfolio license for the personal and non-commercial use of a consumer to (i) encode video in compliance with the AVC Standard ("AVC Video") and/or (ii) decode AVC Video that was encoded by a consumer engaged in a personal and non-commercial activity and/or was obtained from a video provider licensed to provide AVC Video. No license is granted or shall be implied for any other use. Additional information may be obtained from MPEG LA, LLC.

See <http://www.mpegla.com> .

**Panasonic Corporation**

Web Site: <http://panasonic.net>

© Panasonic Corporation 2013